

gebo g316

TVAROVKY Z NEREZOVÉ OCELI



NEREZOVÁ OCEL



ZÁVITOVÉ FITINKY

S. 227-242

- Všechny odlitky jsou vyrobeny z materiálu 1.4408
- Legující složky v%: C <= 0,07 · Cr 18,0 - 20,0 · Ni 9,0 - 12,0 · Mo 2,0 - 2,5
- Oblouky kód 6003 a nátrubky kód 6270 a 6272 jsou vyrobeny z materiálu 1.4404 (AISI 316L)
- Šroubení s plochým těsněním jsou vybaveny těsněním PTFE
- Všechny položky jsou označeny tlakovými stupni 150 liber ~ 10,5 bar
- Oblasti použití materiálů 1.4408 + 1.4404: voda, pitná voda, chemické látky, potravinářský sektor
- Dobrá odolnost proti korozi a kyselinám
- Maximální provozní teplota (bez dalšího mechanického namáhání): 220 ° C
- Připojovací závit podle DIN EN 10226-1 (ISO 7/1)



ZÁVITOVÉ MEZIKUSY

S. 242-243

- Všechny mezikusy se závitem a navařovací mezikusy jsou vyrobeny ze svařovaných trubek (materiál 1.4404) podle DIN EN 10255 (rozměry) a DIN EN 10241 (délka)
- Vhodné pro média: vodu, pitnou vodu, různé chemické látky
- Maximální tlakový stupeň 50 bar (20 ° C)
- Závit podle DIN EN 10226-1 (ISO 7/1)



KULOVÉ KOHOUTY

S. 244-248

- Těla kulových kohoutů jsou vyrobena z materiálu CF8M, názvy materiálů jednotlivých částí jsou uvedeny v tabulkách pod produkty
- Všechny kulové kohouty jsou vybaveny těsněním PTFE
- Všechny kulové kohouty jsou označeny max. povolený tlakový stupeň PN63
- Poměr teploty vůči tlaku lze zjistit z diagramů uvedených u produktů
- Oblast použití: voda, pitná voda, různé chemické látky
- Dobrá odolnost proti korozi a kyselinám
- Všechny kulové kohouty jsou osazeny bezpečnostní pojistkou
- Závit podle DIN EN 10226-1 (ISO 7/1)



NEREZOVÉ ZAHRADNÍ KULOVÉ KOHOUTY

S. 249

- Jednodílný plnopřítokový kulový kohout s bezpečnostní západkou a hadicovou přípojkou
- Vnější závitové připojení DIN EN 10226-1/ISO 7/1

CERTIFIKOVANÉ VÝROBKY



STROJÍRENSKÝ
ZKUŠEBNÍ ÚSTAV

3		OBLOUK DLOUHÝ 90°, M/M					MAT. 1.4404	
Velikost	Číslo produktu	Rozměry [mm]					Kusů/ karton	Kusů/ balení
		L						
1/4"	6003-014	60,0					50	5
3/8"	6003-038	70,0					50	5
1/2"	6003-012	80,0					50	5
3/4"	6003-034	100,0					50	2
1"	6003-100	120,0					50	2
1 1/4"	6003-114	140,0					10	1
1 1/2"	6003-112	160,0					8	1
2"	6003-200	190,0					5	1

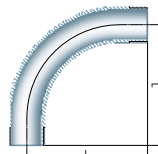

90		KOLENO 90°, F/F					MAT. 1.4408	
Velikost	Číslo produktu	Rozměry [mm]					Kusů/ karton	Kusů/ balení
		L	D1					
1/8"	6090-018	17,0	13,0				250	10
1/4"	6090-014	19,0	16,0				400	10
3/8"	6090-038	23,0	20,0				250	10
1/2"	6090-012	27,0	24,5				250	10
3/4"	6090-034	32,0	30,0				150	5
1"	6090-100	38,0	37,5				100	5
1 1/4"	6090-114	45,0	46,5				50	2
1 1/2"	6090-112	48,0	53,0				36	2
2"	6090-200	57,0	65,5				20	2
2 1/2"	6090-212	69,0	82,0				10	1
3"	6090-300	78,0	95,5				8	1
4"	6090-400	96,0	121,5				2	1

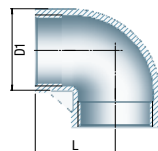

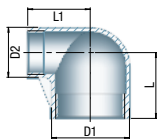

90		REDUKOVANÉ KOLENO 90°F/F				MAT. 1.4408	
Velikost [1 x 2]	Číslo produktu	Rozměry [mm]				Kusů/ karton	Kusů/ balení
		L	L1	D1	D2		
1/2" x 3/8"	6090-012038	25,0	26,0	24,5	20,0	60	10
3/4" x 3/8"	6090-034038	28,0	28,0	30,0	20,0	35	5
3/4" x 1/2"	6090-034012	30,0	29,0	30,0	24,5	35	5
1" x 1/2"	6090-100012	33,0	32,0	37,5	24,5	20	5
1" x 3/4"	6090-100034	35,0	34,0	37,5	30,0	20	5
1 1/4" x 3/4"	6090-114034	40,0	38,0	46,5	30,0	12	2
1 1/4" x 1"	6090-114100	42,0	40,0	46,5	37,5	12	2
1 1/2" x 1"	6090-112100	45,0	41,0	53,0	37,5	7	1
1 1/2" x 1 1/4"	6090-112114	48,0	45,0	53,0	46,5	7	1
2" x 1 1/4"	6090-200114	54,0	48,0	65,5	46,5	10	1
2" x 1 1/2"	6090-200112	55,0	52,0	65,5	53,0	10	1

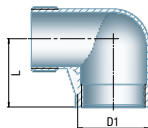

92		KOLENO 90°, SHODNÉ, M/F				MAT. 1.4408	
Velikost	Číslo produktu	Rozměry [mm]				Kusů/ karton	Kusů/ balení
		L	D1				
1/8"	6092-018	17,0	13,0			250	10
1/4"	6092-014	19,0	16,0			350	10
3/8"	6092-038	23,0	20,0			250	10
1/2"	6092-012	27,0	24,5			300	10
3/4"	6092-034	32,0	30,0			150	5
1"	6092-100	38,0	37,5			100	5
1 1/4"	6092-114	45,0	46,5			50	2
1 1/2"	6092-112	48,0	53,0			38	2
2"	6092-200	57,0	65,5			18	2
2 1/2"	6092-212	69,0	82,0			10	1
3"	6092-300	78,0	95,5			6	1
4"	6092-400	97,0	121,5			2	1

95		ROHOVÉ ŠROUBENÍ 90°, PLOCHÉ TĚSNĚNÍ, F/F					MAT. 1.4408	
Velikost	Číslo produktu	Rozměry [mm]				Kusů/ karton	Kusů/ balení	
		L	L1	D1	H			
1/4"	6095-014	46,5	13,5	16,0	17,0	50	5	
3/8"	6095-038	51,0	15,0	19,0	20,0	35	5	
1/2"	6095-012	56,0	16,0	26,0	27,0	25	5	
3/4"	6095-034	61,0	17,0	31,5	31,0	15	5	
1"	6095-100	70,5	20,0	39,0	36,0	14	2	
1 1/4"	6095-114	78,0	22,0	47,5	42,0	12	2	
1 1/2"	6095-112	83,0	24,0	54,0	46,0	20	2	
2"	6095-200	96,0	27,0	66,5	56,0	5	1	

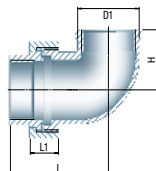

96		ROHOVÉ ŠROUBENÍ 90°, KÓNICKÉ TĚSNĚNÍ, F/F					MAT. 1.4408	
Velikost	Číslo produktu	Rozměry [mm]				Kusů/ karton	Kusů/ balení	
		L	L1	D1	H			
1/4"	6096-014	46,5	13,5	16,0	17,0	50	5	
3/8"	6096-038	51,0	15,0	19,0	20,0	35	5	
1/2"	6096-012	56,0	16,0	26,0	27,0	25	5	
3/4"	6096-034	61,0	17,0	31,5	31,0	15	5	
1"	6096-100	70,5	20,0	39,0	36,0	14	2	
1 1/4"	6096-114	78,0	22,0	47,5	42,0	12	2	
1 1/2"	6096-112	83,0	24,0	54,0	46,0	20	2	
2"	6096-200	96,0	27,0	66,5	56,0	5	1	

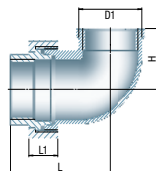

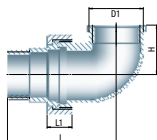

97		ROHOVÉ ŠROUBENÍ, 90°, PLOCHÉ TĚSNĚNÍ, M/F					MAT. 1.4408	
Velikost	Číslo produktu	Rozměry [mm]				Kusů/karton	Kusů/balení	
		L	L1	D1	H			
1/4"	6097-014	57,0	13,5	16,0	17,0	45	5	
3/8"	6097-038	62,0	15,0	19,0	20,0	30	5	
1/2"	6097-012	70,5	16,0	26,0	27,0	20	5	
3/4"	6097-034	76,5	17,0	31,5	31,0	15	5	
1"	6097-100	88,5	20,0	39,0	36,0	14	2	
1 1/4"	6097-114	100,0	22,0	47,5	42,0	10	2	
1 1/2"	6097-112	103,5	24,0	54,0	46,0	10	2	
2"	6097-200	121,0	27,0	66,5	56,0	2	2	

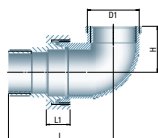

98		ROHOVÉ ŠROUBENÍ 90°, KÓNICKÉ TĚSNĚNÍ, M/F					MAT. 1.4408	
Velikost	Číslo produktu	Rozměry [mm]				Kusů/karton	Kusů/balení	
		L	L1	D1	H			
1/4"	6098-014	57,0	13,5	16,0	17,0	45	5	
3/8"	6098-038	62,0	15,0	19,0	20,0	30	5	
1/2"	6098-012	70,5	16,0	26,0	27,0	20	5	
3/4"	6098-034	76,5	17,0	31,5	31,0	15	5	
1"	6098-100	88,5	20,0	39,0	36,0	14	2	
1 1/4"	6098-114	100,0	22,0	47,5	42,0	10	2	
1 1/2"	6098-112	103,5	24,0	54,0	46,0	10	2	
2"	6098-200	121,0	27,0	66,5	56,0	2	2	

120	KOLENO 45°, F/F					MAT. 1.4408	
Velikost	Číslo produktu	Rozměry [mm]				Kusů/karton	Kusů/balení
		L	D1				
1/8"	6120-018	16,0	13,0			250	10
1/4"	6120-014	17,0	16,0			250	10
3/8"	6120-038	19,0	20,0			120	10
1/2"	6120-012	21,0	24,5			100	10
3/4"	6120-034	25,0	30,0			60	5
1"	6120-100	29,0	37,5			50	5
1 1/4"	6120-114	33,0	46,5			18	2
1 1/2"	6120-112	37,0	53,0			14	2
2"	6120-200	42,0	65,5			12	2

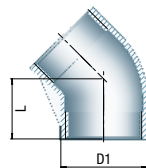

121	KOLENO 45°, M/F					MAT. 1.4408	
Velikost	Číslo produktu	Rozměry [mm]				Kusů/karton	Kusů/balení
		L	D1				
1/4"	6121-014	19,0	16,0			200	10
3/8"	6121-038	23,0	20,0			120	10
1/2"	6121-012	27,0	24,5			150	10
3/4"	6121-034	32,0	30,0			35	5
1"	6121-100	38,0	37,5			80	5
1 1/4"	6121-114	45,0	46,5			12	2
1 1/2"	6121-112	48,0	53,0			30	2
2"	6121-200	57,0	65,5			16	2

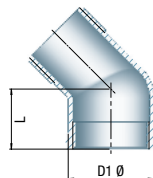

130	T-KUS 90°, SHODNÝ, F/F/F					MAT. 1.4408	
Velikost	Číslo produktu	Rozměry [mm]				Kusů/karton	Kusů/balení
		L	D1				
1/8"	6130-018	17,0	13,0			110	10
1/4"	6130-014	19,0	16,5			400	10
3/8"	6130-038	23,0	20,0			300	10
1/2"	6130-012	27,0	24,5			150	5
3/4"	6130-034	32,0	30,0			80	5
1"	6130-100	38,0	37,5			60	5
1 1/4"	6130-114	45,0	46,5			40	2
1 1/2"	6130-112	48,0	53,0			30	2
2"	6130-200	57,0	65,5			18	2
2 1/2"	6130-212	69,0	82,0			6	1
3"	6130-300	78,0	95,5			5	1

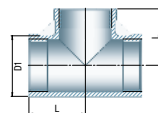

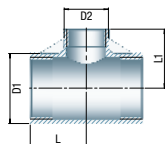

130		T-KUS 90°, REDUKČNÍ F/F/F				MAT. 1.4408	
Velikost [1x2]	Číslo produktu	Rozměry [mm]				Kusů/karton	Kusů/balení
		L	L1	D1	D2		
1/4" x 1/8"	6130-014018	18,0	18,0	16,0	13,0	100	10
3/8" x 1/4"	6130-038014	20,0	22,0	20,0	16,0	70	10
1/2" x 1/4"	6130-012014	24,0	24,0	24,5	16,0	35	5
1/2" x 3/8"	6130-012038	26,0	25,0	24,5	20,0	35	5
3/4" x 3/8"	6130-034038	28,0	28,0	30,0	20,0	20	5
3/4" x 1/2"	6130-034012	29,0	30,0	30,0	24,5	40	5
1" x 1/2"	6130-100012	32,0	33,0	37,5	24,5	30	5
1" x 3/4"	6130-100034	34,0	35,0	37,5	30,0	15	5
1 1/4" x 3/4"	6130-114034	38,0	40,0	46,5	30,0	10	2
1 1/4" x 1"	6130-114100	40,0	42,0	46,5	37,5	10	2
1 1/2" x 3/4"	6130-112034	37,0	43,0	53,0	30,0	6	2
1 1/2" x 1"	6130-112100	41,0	45,0	53,0	37,5	6	2
1 1/2" x 1 1/4"	6130-112114	45,0	48,0	53,0	46,5	6	2
2" x 1"	6130-200100	44,0	51,0	65,5	37,5	9	1
2" x 1 1/4"	6130-200114	48,0	54,0	65,5	46,5	9	1
2" x 1 1/2"	6130-200112	52,0	55,0	65,5	53,0	9	1

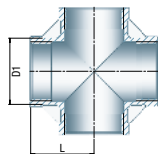

180		KŘÍŽ SHODNÝ, F/F/F/F				MAT. 1.4408	
Velikost	Číslo produktu	Rozměry [mm]				Kusů/karton	Kusů/balení
		L	D1				
1/8"	6180-018	17,0	13,0			120	10
1/4"	6180-014	19,0	16,0			100	10
3/8"	6180-038	23,0	20,0			30	10
1/2"	6180-012	27,0	24,5			25	5
3/4"	6180-034	32,0	30,0			15	5
1"	6180-100	38,0	37,5			12	2
1 1/4"	6180-114	45,0	46,5			10	2
1 1/2"	6180-112	48,0	53,0			8	2
2"	6180-200	57,0	65,5			8	2

220		Y(ODBOČKA, SHODNÁ, F/F/F				MAT. 1.4408	
Velikost	Číslo produktu	Rozměry [mm]				Kusů/karton	Kusů/balení
		L	D1				
1/4"	6220-014	19,0	18,0			75	5
3/8"	6220-038	23,0	21,5			60	10
1/2"	6220-012	27,0	26,5			30	5
3/4"	6220-034	32,0	32,0			15	5
1"	6220-100	40,9	43,2			25	5
1 1/4"	6220-114	45,0	49,0			14	2
1 1/2"	6220-112	48,0	55,5			10	2
2"	6220-200	57,0	68,5			5	1

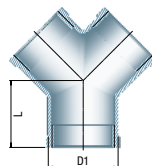

240		REDUKOVANÝ NÁTRUBEK, F/F				MAT. 1.4408	
Velikost	Číslo produktu	Rozměry [mm]				Kusů/karton	Kusů/balení
		L	D1	D2			
1/4" x 1/8"	6240-014018	25,0	17,5	14,0		250	10
3/8" x 1/8"	6240-038018	23,0	21,0	14,0		180	10
3/8" x 1/4"	6240-038014	26,0	21,0	17,5		180	10
1/2" x 1/8"	6240-012018	34,0	26,5	14,0		120	10
1/2" x 1/4"	6240-012014	34,0	26,5	17,5		120	10
1/2" x 3/8"	6240-012038	34,0	26,5	21,0		120	10
3/4" x 1/8"	6240-034018	36,0	32,0	14,0		75	5
3/4" x 1/4"	6240-034014	36,0	32,0	17,5		75	5
3/4" x 3/8"	6240-034038	36,0	32,0	21,0		75	5
3/4" x 1/2"	6240-034012	36,0	32,0	25,5		150	5
1" x 3/8"	6240-100038	42,0	39,0	21,0		45	5
1" x 1/2"	6240-100012	42,0	39,0	25,5		180	5
1" x 3/4"	6240-100034	42,0	39,0	31,0		90	5
1 1/4" x 1/2"	6240-114012	48,0	48,0	25,5		30	5
1 1/4" x 3/4"	6240-114034	48,0	48,0	31,0		30	5
1 1/4" x 1"	6240-114100	48,0	48,0	39,0		60	5
1 1/2" x 1/2"	6240-112012	52,0	54,0	25,5		25	5
1 1/2" x 3/4"	6240-112034	52,0	54,0	31,0		25	5
1 1/2" x 1"	6240-112100	52,0	54,0	39,0		50	5
1 1/2" x 1 1/4"	6240-112114	52,0	54,0	48,0		50	5
2" x 1/2"	6240-200012	58,0	67,5	25,5		25	5
2" x 3/4"	6240-200034	58,0	67,5	31,0		24	2
2" x 1"	6240-200100	58,0	67,5	39,0		12	2
2" x 1 1/4"	6240-200114	58,0	67,5	48,0		50	5
2" x 1 1/2"	6240-200112	58,0	67,5	54,0		25	5
2 1/2" x 1 1/2"	6240-212112	65,0	84,0	54,0		10	2
2 1/2" x 2"	6240-212200	65,0	84,0	67,5		10	2
3" x 2"	6240-300200	72,0	98,0	67,5		8	1
3" x 2 1/2"	6240-300212	72,0	98,0	84,0		8	1
4" x 2"	6240-400200	94,0	125,0	67,5		5	1
4" x 2 1/2"	6240-400212	94,0	125,0	84,0		5	1
4" x 3"	6240-400300	94,0	125,0	98,0		5	1

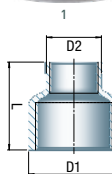



241	REDUKCE, M/F				MAT. 1.4408	
Velikost [1 x 2]	Číslo produktu	Rozměry [mm]			Kusů/karton	Kusů/balení
		L	SW			
1/4" x 1/8"	6241-014018	16,0	14,0		250	10
3/8" x 1/8"	6241-038018	16,5	18,0		200	10
3/8" x 1/4"	6241-038014	16,5	18,0		400	10
1/2" x 1/8"	6241-012018	20,0	22,0		175	5
1/2" x 1/4"	6241-012014	20,0	22,0		700	5
1/2" x 3/8"	6241-012038	20,0	22,0		700	5
3/4" x 1/8"	6241-034018	21,0	27,5		125	5
3/4" x 1/4"	6241-034014	21,0	27,5		125	5
3/4" x 3/8"	6241-034038	21,0	27,5		125	5
3/4" x 1/2"	6241-034012	21,0	27,5		500	5
1" x 1/4"	6241-100014	24,5	34,5		75	5
1" x 3/8"	6241-100038	24,5	34,5		75	5
1" x 1/2"	6241-100012	24,5	34,5		300	5
1" x 3/4"	6241-100034	24,5	34,5		300	5
1 1/4" x 3/8"	6241-114038	27,5	43,0		50	5
1 1/4" x 1/2"	6241-114012	27,5	43,0		50	5
1 1/4" x 3/4"	6241-114034	27,5	43,0		100	5
1 1/4" x 1"	6241-114100	27,5	43,0		200	5
1 1/2" x 3/8"	6241-112038	28,5	49,0		70	5
1 1/2" x 1/2"	6241-112012	28,5	49,0		35	5
1 1/2" x 3/4"	6241-112034	28,5	49,0		35	5
1 1/2" x 1"	6241-112100	28,5	49,0		150	5
1 1/2" x 1 1/4"	6241-112114	28,5	49,0		150	5
2" x 1/2"	6241-200012	33,0	61,0		22	2
2" x 3/4"	6241-200034	33,0	61,0		22	2
2" x 1"	6241-200100	33,0	61,0		90	2
2" x 1 1/4"	6241-200114	33,0	61,0		90	2
2" x 1 1/2"	6241-200112	33,0	61,0		90	2
2 1/2" x 1"	6241-212100	37,0	76,0		12	2
2 1/2" x 1 1/4"	6241-212114	37,0	76,0		12	2
2 1/2" x 1 1/2"	6241-212112	37,0	76,0		12	2
2 1/2" x 2"	6241-212200	37,0	76,0		48	2
3" x 1 1/4"	6241-300114	40,0	90,0		15	1
3" x 1 1/2"	6241-300112	40,0	90,0		15	1
3" x 2"	6241-300200	40,0	90,0		30	1
3" x 2 1/2"	6241-300212	40,0	90,0		15	1
4" x 2"	6241-400200	46,0	115,0		10	1
4" x 2 1/2"	6241-400212	46,0	115,0		10	1
4" x 3"	6241-400300	46,0	115,0		10	1

245	REDUKOVANÁ VSVUKA, M/M				MAT. 1.4408	
Velikost [1x2]	Číslo produktu	Rozměry [mm]			Kusů/karton	Kusů/balení
		L	e	SW		
1/4" x 1/8"	6245-014018	22,5	17,3	15,0	370	10
3/8" x 1/8"	6245-038018	24,0	20,8	18,0	250	10
3/8" x 1/4"	6245-038014	26,5	20,8	18,0	250	10
1/2" x 1/8"	6245-012018	27,5	25,4	22,0	150	5
1/2" x 1/4"	6245-012014	30,0	25,4	22,0	150	5
1/2" x 3/8"	6245-012038	30,5	25,4	22,0	300	5
3/4" x 1/4"	6245-034014	31,5	32,3	28,0	75	5
3/4" x 3/8"	6245-034038	32,0	32,3	28,0	75	5
3/4" x 1/2"	6245-034012	35,5	32,3	28,0	300	5
1" x 1/4"	6245-100014	34,5	40,4	35,0	55	5
1" x 3/8"	6245-100038	35,0	40,4	35,0	55	5
1" x 1/2"	6245-100012	38,5	40,4	35,0	110	5
1" x 3/4"	6245-100034	39,5	40,4	35,0	220	5
1 1/4" x 1/2"	6245-114012	41,5	50,2	43,5	30	2
1 1/4" x 3/4"	6245-114034	42,5	47,1	43,5	30	2
1 1/4" x 1"	6245-114100	45,0	50,2	43,5	120	2
1 1/2" x 1/2"	6245-112012	41,5	57,2	49,5	18	2
1 1/2" x 3/4"	6245-112034	42,5	57,2	49,5	18	2
1 1/2" x 1"	6245-112100	45,0	57,2	49,5	74	2
1 1/2" x 1 1/4"	6245-112114	47,5	57,2	49,5	36	2
2" x 1/2"	6245-200012	46,5	71,6	62,0	12	2
2" x 3/4"	6245-200034	47,5	71,6	62,0	12	2
2" x 1"	6245-200100	50,0	71,6	62,0	24	2
2" x 1 1/4"	6245-200114	52,5	67,1	62,0	24	2
2" x 1 1/2"	6245-200112	52,5	71,6	62,0	50	2
2 1/2" x 1 1/2"	6245-212112	54,5	89,5	77,5	6	2
2 1/2" x 2"	6245-212200	59,0	81,5	77,5	24	2
3" x 1 1/2"	6245-300112	58,0	95,1	90,5	10	1
3" x 2"	6245-300200	62,5	104,5	90,5	10	1
3" x 2 1/2"	6245-300212	64,5	104,5	90,5	10	1
4" x 2"	6245-400200	69,0	125,6	116,0	5	1
4" x 2 1/2"	6245-400212	71,0	121,9	116,0	5	1
4" x 3"	6245-400300	74,0	125,6	116,0	5	1

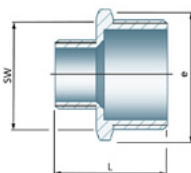

270	NÁTRUBEK, F/F, STANDARTNÍ DÉLKA			MAT. 1.4404		
Velikost	Číslo produktu	Rozměry [mm]			Kusů/karton	Kusů/balení
		L	D1			
1/8"	6270-018	17,0	14,0		250	10
1/4"	6270-014	25,0	18,5		800	10
3/8"	6270-038	26,0	21,3		370	10
1/2"	6270-012	34,0	26,4		450	5
3/4"	6270-034	36,0	31,8		300	5
1"	6270-100	43,0	39,5		180	5
1 1/4"	6270-114	48,0	48,3		100	5
1 1/2"	6270-112	48,0	54,5		70	5
2"	6270-200	56,0	66,3		45	5
2 1/2"	6270-212	65,0	82,0		24	2
3"	6270-300	71,0	95,0		16	1
4"	6270-400	83,0	122,0		10	1

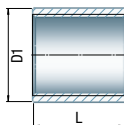

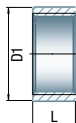

272		NÁTRUBEK, F/F, POLOVIČNÍ DÉLKA				MAT. 1.4404	
Velikost	Číslo produktu	Rozměry [mm]				Kusů/karton	Kusů/balení
		L	D1				
1/8"	6272-018	10,0	14,0			500	10
1/4"	6272-014	11,0	18,5			450	10
3/8"	6272-038	12,0	21,3			350	10
1/2"	6272-012	15,0	26,4			400	5
3/4"	6272-034	17,0	31,8			300	5
1"	6272-100	19,5	39,5			175	5
1 1/4"	6272-114	22,0	48,3			100	5
1 1/2"	6272-112	22,0	54,5			140	5
2"	6272-200	26,0	66,3			90	5
2 1/2"	6272-212	30,5	82,0			10	2
3"	6272-300	34,0	95,0			15	1
4"	6272-400	39,0	122,0			10	1

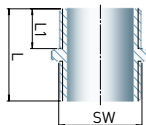

280		VSUVKA, M/M				MAT. 1.4408	
Velikost	Číslo produktu	Rozměry [mm]				Kusů/karton	Kusů/balení
		L	L1	SW			
1/8"	6280-018	20,0	8,0	11,0		370	10
1/4"	6280-014	25,0	10,5	15,0		750	10
3/8"	6280-038	27,0	11,0	18,0		500	10
1/2"	6280-012	34,0	14,5	22,0		600	10
3/4"	6280-034	36,5	15,5	28,0		300	5
1"	6280-100	42,0	18,0	35,0		200	5
1 1/4"	6280-114	47,5	20,5	43,5		120	2
1 1/2"	6280-112	17,5	20,5	49,5		74	2
2"	6280-200	57,0	25,0	62,0		50	2
2 1/2"	6280-212	61,0	27,0	77,5		24	1
3"	6280-300	67,5	30,0	90,5		20	1
4"	6280-400	80,0	36,0	117,0		10	1

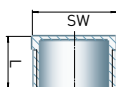

290		ZÁTKA, ŠESTIHRAN				MAT. 1.4408	
Velikost	Číslo produktu	Rozměry [mm]				Kusů/karton	Kusů/balení
		L	SW				
1/8"	6290-018	12,0	11,0			500	10
1/4"	6290-014	14,5	15,0			370	10
3/8"	6290-038	16,0	18,0			500	10
1/2"	6290-012	19,5	22,0			800	5
3/4"	6290-034	21,0	28,0			400	5
1"	6290-100	24,0	35,0			300	5
1 1/4"	6290-114	27,0	43,5			130	5
1 1/2"	6290-112	27,0	49,5			120	5
2"	6290-200	32,0	62,0			80	5
2 1/2"	6290-212	34,0	77,5			14	2
3"	6290-300	37,5	90,5			20	1
4"	6290-400	44,0	117,0			7	1

291		ZÁTKA, ČTYŘHRAN, BEZ OBRUBY				MAT. 1.4408	
Velikost	Číslo produktu	Rozměry [mm]				Kusů/karton	Kusů/balení
		L	SW				
1/8"	6291-018	11,0	6,0			500	10
1/4"	6291-014	13,5	7,0			500	10
3/8"	6291-038	15,0	8,0			370	10
1/2"	6291-012	18,5	10,0			500	5
3/4"	6291-034	21,0	12,0			150	5
1"	6291-100	25,5	14,0			180	5
1 1/4"	6291-114	28,8	16,0			50	5
1 1/2"	6291-112	29,0	20,0			35	5
2"	6291-200	34,5	22,0			50	5
2 1/2"	6291-212	38,5	28,0			12	2
3"	6291-300	41,5	32,0			16	1
4"	6291-400	51,5	40,0			10	1

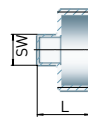

300		VÍČKO, ŠESTIHRAN				MAT. 1.4408	
Velikost	Číslo produktu	Rozměry [mm]				Kusů/karton	Kusů/balení
		L	SW				
1/8"	6300-018	12,5	13,5			370	10
1/4"	6300-014	16,0	17,0			250	10
3/8"	6300-038	16,5	20,5			150	10
1/2"	6300-012	21,0	25,0			400	5
3/4"	6300-034	22,5	31,0			200	5
1"	6300-100	26,0	38,0			200	5
1 1/4"	6300-114	29,0	47,0			150	5
1 1/2"	6300-112	29,0	53,0			100	5
2"	6300-200	33,5	66,0			70	5
2 1/2"	6300-212	38,5	82,0			14	2
3"	6300-300	42,0	95,5			10	1
4"	6300-400	48,5	121,5			7	1

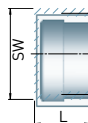

310		MATICE PŘÍTUŽNÁ				MAT. 1.4408	
Velikost	Číslo produktu	Rozměry [mm]				Kusů/karton	Kusů/balení
		L	SW				
1/8"	6310-018	5,0	15,0			500	10
1/4"	6310-014	6,0	18,0			500	10
3/8"	6310-038	6,0	22,0			500	10
1/2"	6310-012	7,0	27,0			600	10
3/4"	6310-034	7,0	32,0			250	5
1"	6310-100	9,0	40,0			200	5
1 1/4"	6310-114	11,0	48,0			100	5
1 1/2"	6310-112	11,0	55,0			300	5
2"	6310-200	13,0	68,0			35	5
2 1/2"	6310-212	15,0	85,0			30	2
3"	6310-300	17,0	100,0			50	2
4"	6310-400	20,0	125,0			24	2



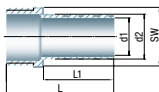

315		HADIČNÍK VNĚJŠÍ					MAT. 1.4408	
Velikost	Číslo produktu	Rozměry [mm]					Kusů/karton	Kusů/balení
		L	L1	d1	d2	SW		
1/8" x 7 mm	6315-1807	33,0	19,0	3,2	6,0	11,0	250	10
1/4" x 9 mm	6315-1409	42,5	28,0	5,0	9,0	15,0	200	10
3/8" x 11 mm	6315-3811	49,0	33,0	7,0	11,0	18,0	120	10
1/2" x 13 mm	6315-1213	59,5	38,0	8,0	13,0	22,0	500	10
3/4" x 20 mm	6315-3420	66,0	45,0	15,0	20,0	28,0	250	5
1" x 25 mm	6315-1025	75,0	48,0	20,0	25,0	36,0	150	5
1 1/4" x 33 mm	6315-11433	79,0	52,0	27,5	33,0	43,5	100	2
1 1/2" x 40 mm	6315-11240	83,0	56,0	34,0	40,0	49,5	72	2
2" x 52 mm	6315-2052	92,0	60,0	45,0	52,0	62,0	30	2
2 1/2" x 63,5 mm	6315-212635	100,0	62,5	56,0	63,5	77,5	15	1
3" x 76,5 mm	6315-30765	110,0	70,0	67,0	76,5	90,5	12	1
4" x 100 mm	6315-40100	120,0	73,0	90,0	100,0	117,0	4	1

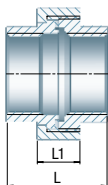

330		ŠROUBENÍ, PLOCHÉ TĚSNĚNÍ, F/F					MAT. 1.4408	
Velikost	Číslo produktu	Rozměry [mm]					Kusů/karton	Kusů/balení
		L	L1					
1/8"	6330-018	30,0	13,0				50	10
1/4"	6330-014	33,5	13,5				50	10
3/8"	6330-038	36,5	15,0				50	5
1/2"	6330-012	39,5	16,0				200	5
3/4"	6330-034	42,5	17,0				140	5
1"	6330-100	50,0	20,0				84	2
1 1/4"	6330-114	54,0	22,0				45	5
1 1/2"	6330-112	58,0	24,0				45	5
2"	6330-200	65,0	27,0				24	2
2 1/2"	6330-212	75,0	29,5				5	1
3"	6330-300	83,0	31,0				5	1
4"	6330-400	110,0	34,0				4	1

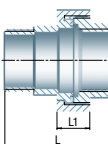

331		ŠROUBENÍ, PLOCHÉ TĚSNĚNÍ, M/F					MAT. 1.4408	
Velikost	Číslo produktu	Rozměry [mm]					Kusů/karton	Kusů/balení
		L	L1					
1/8"	6331-018	38,0	13,0				55	5
1/4"	6331-014	44,0	13,5				50	5
3/8"	6331-038	47,5	15,0				50	5
1/2"	6331-012	54,0	16,0				120	2
3/4"	6331-034	58,0	17,0				60	5
1"	6331-100	68,0	20,0				35	5
1 1/4"	6331-114	74,5	22,0				35	5
1 1/2"	6331-112	78,5	24,0				20	2
2"	6331-200	90,0	27,0				16	2
2 1/2"	6331-212	102,0	29,5				6	1
3"	6331-300	113,0	31,0				4	1

332		ŠROUBENÍ, PLOCHÉ TĚSNĚNÍ, OBOUSTRANNÉ VARNÉ					MAT. 1.4408	
Velikost	Číslo produktu	Rozměry [mm]					Kusů/ karton	Kusů/ balení
		L	L1	D1	d2			
1/4"	6332-014	33,5	13,5	13,5	8,8		50	10
3/8"	6332-038	36,5	15,0	17,2	12,5		50	5
1/2"	6332-012	39,5	16,0	21,3	16,0		50	5
3/4"	6332-034	42,5	17,0	26,9	21,6		35	5
1"	6332-100	50,0	20,0	33,7	27,2		40	5
1 1/4"	6332-114	54,0	22,0	42,4	35,9		45	5
1 1/2"	6332-112	58,0	24,0	48,3	41,8		20	5
2"	6332-200	65,0	27,0	60,3	53,0		24	2
2 1/2"	6332-212	75,0	29,5	76,1	68,8		5	1
3"	6332-300	83,0	31,0	88,9	80,8		5	1

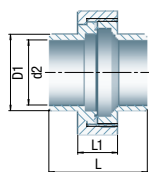

333		ŠROUBENÍ, PLOCHÉ TĚSNĚNÍ, VNĚJŠÍ ZÁVIT / JEDNOSTRANNÉ VARNÉ					MAT. 1.4408	
Velikost	Číslo produktu	Rozměry [mm]					Kusů/ karton	Kusů/ balení
		L	L1	D1	d2			
1/4"	6333-014	45,0	13,5	13,5	8,8		50	5
3/8"	6333-038	48,8	15,0	17,2	12,5		50	5
1/2"	6333-012	56,3	16,0	21,3	16,0		30	2
3/4"	6333-034	59,3	17,0	26,9	21,6		15	5
1"	6333-100	69,0	20,0	33,7	27,2		35	5
1 1/4"	6333-114	74,5	22,0	42,4	35,9		15	5
1 1/2"	6333-112	78,0	24,0	48,3	41,8		20	2
2"	6333-200	96,0	27,0	60,3	53,0		8	2
2 1/2"	6333-212	99,3	29,5	76,1	68,8		2	1

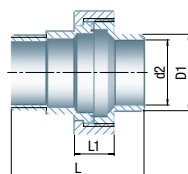

334		ŠROUBENÍ, PLOCHÉ TĚSNĚNÍ, VNITŘNÍ ZÁVIT / JEDNOSTRANNÉ VARNÉ					MAT. 1.4408	
Velikost	Číslo produktu	Rozměry [mm]					Kusů/ karton	Kusů/ balení
		L	L1	D1	d2			
1/4"	6334-014	34,5	13,5	13,5	8,8		50	10
3/8"	6334-038	37,8	15,0	17,2	12,5		50	5
1/2"	6334-012	41,8	16,0	21,3	16,0		50	5
3/4"	6334-034	43,8	17,0	26,9	21,6		35	5
1"	6334-100	51,0	20,0	33,7	27,2		40	5
1 1/4"	6334-114	54,0	22,0	42,4	35,9		20	5
1 1/2"	6334-112	57,5	24,0	48,3	41,8		20	5
2"	6334-200	71,0	27,0	60,3	53,0		24	2

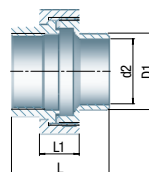

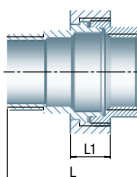
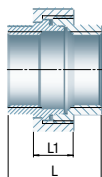
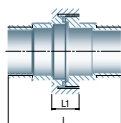

335		ŠROUBENÍ, PLOCHÉ TĚSNĚNÍ, M/M				MAT. 1.4408	
Velikost	Číslo produktu	Rozměry [mm]				Kusů/karton	Kusů/balení
		L	L1				
1/2"	6335-012	68,5	16,0			25	5
3/4"	6335-034	73,5	17,0			10	5
1"	6335-100	86,0	20,0			5	5
1 1/4"	6335-114	95,0	22,0			10	2
1 1/2"	6335-112	99,0	24,0			15	5

340		ŠROUBENÍ, KÓNICKÉ TĚSNĚNÍ, F/F				MAT. 1.4408	
Velikost	Číslo produktu	Rozměry [mm]				Kusů/karton	Kusů/balení
		L	L1				
1/8"	6340-018	30,0	13,0			50	10
1/4"	6340-014	33,5	13,5			50	10
3/8"	6340-038	36,5	15,0			50	5
1/2"	6340-012	39,5	16,0			200	5
3/4"	6340-034	42,5	17,0			140	5
1"	6340-100	50,0	20,0			84	2
1 1/4"	6340-114	54,0	22,0			45	5
1 1/2"	6340-112	58,0	24,0			45	5
2"	6340-200	65,0	27,0			24	2
2 1/2"	6340-212	75,0	29,5			5	1
3"	6340-300	83,0	31,0			5	1
4"	6340-400	110,0	34,0			4	1

341		ŠROUBENÍ, KÓNICKÉ TĚSNĚNÍ, M/F				MAT. 1.4408	
Velikost	Číslo produktu	Rozměry [mm]				Kusů/karton	Kusů/balení
		L	L1				
1/8"	6341-018	38,0	13,0			55	5
1/4"	6341-014	44,0	13,5			50	5
3/8"	6341-038	47,5	15,0			50	5
1/2"	6341-012	54,0	16,0			120	2
3/4"	6341-034	58,0	17,0			60	5
1"	6341-100	68,0	20,0			35	5
1 1/4"	6341-114	74,5	22,0			35	5
1 1/2"	6341-112	78,5	24,0			20	2
2"	6341-200	90,0	27,0			16	2
2 1/2"	6341-212	102,0	29,5			6	1
3"	6341-300	113,0	31,0			2	1

342		ŠROUBENÍ, KÓNICKÉ TĚSNĚNÍ, OBOUSTRANNÉ VARNÉ					MAT. 1.4408	
Velikost	Číslo produktu	Rozměry [mm]					Kusů/ karton	Kusů/ balení
		L	L1	D1	d2			
1/4"	6342-014	35,5	13,5	13,5	8,8		50	10
3/8"	6342-038	38,0	15,0	17,2	12,5		50	5
1/2"	6342-012	44,0	16,0	21,3	16,0		50	5
3/4"	6342-034	45,0	17,0	26,9	21,6		35	5
1"	6342-100	50,0	20,0	33,7	27,2		20	5
1 1/4"	6342-114	55,0	22,0	42,4	35,9		10	5
1 1/2"	6342-112	57,0	24,0	48,3	41,8		45	5
2"	6342-200	65,0	27,0	60,3	53,0		12	2
2 1/2"	6342-212	71,0	29,5	76,1	68,8		5	1
3"	6342-300	80,0	31,0	88,9	80,8		5	1

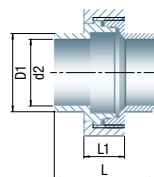

343		ŠROUBENÍ, KÓNICKÉ TĚSNĚNÍ, VNĚJŠÍ ZÁVIT / JEDNOSTRANNÉ VARNÉ					MAT. 1.4408	
Velikost	Číslo produktu	Rozměry [mm]					Kusů/ karton	Kusů/ balení
		L	L1	D1	d2			
1/4"	6343-014	45,0	13,5	13,5	8,8		50	5
3/8"	6343-038	48,8	15,0	17,2	12,5		50	5
1/2"	6343-012	56,3	16,0	21,3	16,0		30	2
3/4"	6343-034	59,3	17,0	26,9	21,6		15	5
1"	6343-100	69,0	20,0	33,7	27,2		35	5
1 1/4"	6343-114	74,5	22,0	42,4	35,9		15	5
1 1/2"	6343-112	78,0	24,0	48,3	41,8		20	2
2"	6343-200	96,0	27,0	60,3	53,0		8	2

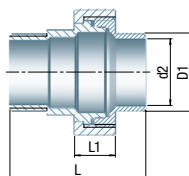

344		ŠROUBENÍ, KÓNICKÉ TĚSNĚNÍ, VNITŘNÍ ZÁVIT / JEDNOSTRANNÉ VARNÉ					MAT. 1.4408	
Velikost	Číslo produktu	Rozměry [mm]					Kusů/ karton	Kusů/ balení
		L	L1	D1	d2			
1/4"	6344-014	34,5	13,5	13,5	8,8		50	10
3/8"	6344-038	37,8	15,0	17,2	12,5		50	5
1/2"	6344-012	41,8	16,0	21,3	16,0		50	5
3/4"	6344-034	43,8	17,0	26,9	21,6		35	5
1"	6344-100	51,0	20,0	33,7	27,2		20	5
1 1/4"	6344-114	54,0	22,0	42,4	35,9		20	5
1 1/2"	6344-112	57,5	24,0	48,3	41,8		20	5
2"	6344-200	71,0	27,0	60,3	53,0		24	2

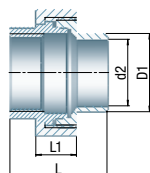

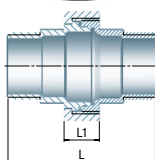

345		ŠROUBENÍ, KÓNICKÉ TĚSNĚNÍ, M/M				MAT. 1.4408	
Velikost	Číslo produktu	Rozměry [mm]				Kusů/karton	Kusů/balení
		L	L1				
1/2"	6345-012	68,5	16,0			25	5
3/4"	6345-034	73,5	17,0			12	2
1"	6345-100	86,0	20,0			6	2
2"	6345-200	115,0	27,0			7	1

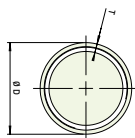
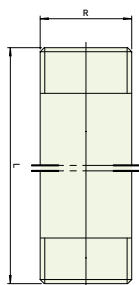

MEZIKUSY, OBOUSTRANNÝ ZÁVIT			MAT. 1.4404	
Závit ISO 7/1 (R) x Délka	Vnější průměr potrubí [d] x síla stěny (t)	Číslo produktu	Kusů/karton	Kusů/balení
1/8" x 40 mm	10,2 x 2,0 mm	6070.040.01	800	10
1/8" x 60 mm	10,2 x 2,0 mm	6070.060.01	500	10
1/8" x 100 mm	10,2 x 2,0 mm	6070.100.01	200	10
1/4" x 30 mm	13,5 x 2,3 mm	6070.030.02	600	10
1/4" x 40 mm	13,5 x 2,3 mm	6070.040.02	600	10
1/4" x 60 mm	13,5 x 2,3 mm	6070.060.02	500	10
1/4" x 80 mm	13,5 x 2,3 mm	6070.080.02	300	10
1/4" x 100 mm	13,5 x 2,3 mm	6070.100.02	250	10
1/4" x 120 mm	13,5 x 2,3 mm	6070.120.02	200	10
1/4" x 150 mm	13,5 x 2,3 mm	6070.150.02	150	10
1/4" x 200 mm	13,5 x 2,3 mm	6070.200.02	100	5
3/8" x 40 mm	17,2 x 2,3 mm	6070.040.03	500	10
3/8" x 60 mm	17,2 x 2,3 mm	6070.060.03	400	10
3/8" x 80 mm	17,2 x 2,3 mm	6070.080.03	300	10
3/8" x 100 mm	17,2 x 2,3 mm	6070.100.03	250	10
3/8" x 120 mm	17,2 x 2,3 mm	6070.120.03	200	10
3/8" x 150 mm	17,2 x 2,3 mm	6070.150.03	150	10
3/8" x 200 mm	17,2 x 2,3 mm	6070.200.03	100	5
1/2" x 40 mm	21,3 x 2,6 mm	6070.040.04	250	10
1/2" x 60 mm	21,3 x 2,6 mm	6070.060.04	250	10
1/2" x 80 mm	21,3 x 2,6 mm	6070.080.04	200	10
1/2" x 100 mm	21,3 x 2,6 mm	6070.100.04	150	10
1/2" x 120 mm	21,3 x 2,6 mm	6070.120.04	100	10
1/2" x 150 mm	21,3 x 2,6 mm	6070.150.04	80	10
1/2" x 200 mm	21,3 x 2,6 mm	6070.200.04	50	5
1/2" x 300 mm	21,3 x 2,6 mm	6070.300.04	40	5
3/4" x 40 mm	26,9 x 2,6 mm	6070.040.05	150	10
3/4" x 60 mm	26,9 x 2,6 mm	6070.060.05	150	10
3/4" x 80 mm	26,9 x 2,6 mm	6070.080.05	100	10
3/4" x 100 mm	26,9 x 2,6 mm	6070.100.05	80	10
3/4" x 120 mm	26,9 x 2,6 mm	6070.120.05	60	10
3/4" x 150 mm	26,9 x 2,6 mm	6070.150.05	50	5
3/4" x 200 mm	26,9 x 2,6 mm	6070.200.05	40	5
3/4" x 300 mm	26,9 x 2,6 mm	6070.300.05	20	5
1" x 40 mm	33,7 x 3,2 mm	6070.040.06	100	10
1" x 60 mm	33,7 x 3,2 mm	6070.060.06	100	10
1" x 80 mm	33,7 x 3,2 mm	6070.080.06	60	10
1" x 100 mm	33,7 x 3,2 mm	6070.100.06	50	5
1" x 120 mm	33,7 x 3,2 mm	6070.120.06	40	5
1" x 150 mm	33,7 x 3,2 mm	6070.150.06	30	5
1" x 200 mm	33,7 x 3,2 mm	6070.200.06	20	5
1" x 300 mm	33,7 x 3,2 mm	6070.300.06	10	5

MEZIKUS, OBOUSTRANNÝ ZÁVIT

MAT. 1.4404

Závit ISO 7/1 (R) x Délka	Vnější průměr potrubí (d) x síla stěny (t)	Číslo produktu	Kusů/karton	Kusů/balení
1 1/4" x 40 mm	42,4 x 3,2 mm	6070.040.07	50	5
1 1/4" x 60 mm	42,4 x 3,2 mm	6070.060.07	50	5
1 1/4" x 80 mm	42,4 x 3,2 mm	6070.080.07	50	5
1 1/4" x 100 mm	42,4 x 3,2 mm	6070.100.07	40	5
1 1/4" x 120 mm	42,4 x 3,2 mm	6070.120.07	30	5
1 1/4" x 150 mm	42,4 x 3,2 mm	6070.150.07	20	5
1 1/4" x 200 mm	42,4 x 3,2 mm	6070.200.07	10	5
1 1/2" x 40 mm	48,3 x 3,2 mm	6070.040.08	40	5
1 1/2" x 60 mm	48,3 x 3,2 mm	6070.060.08	40	5
1 1/2" x 80 mm	48,3 x 3,2 mm	6070.080.08	40	5
1 1/2" x 100 mm	48,3 x 3,2 mm	6070.100.08	30	5
1 1/2" x 120 mm	48,3 x 3,2 mm	6070.120.08	20	5
1 1/2" x 150 mm	48,3 x 3,2 mm	6070.150.08	15	5
1 1/2" x 200 mm	48,3 x 3,2 mm	6070.200.08	10	5
2" x 40 mm	60,3 x 3,6 mm	6070.040.09	20	5
2" x 60 mm	60,3 x 3,6 mm	6070.060.09	20	5
2" x 80 mm	60,3 x 3,6 mm	6070.080.09	20	5
2" x 100 mm	60,3 x 3,6 mm	6070.100.09	20	5
2" x 120 mm	60,3 x 3,6 mm	6070.120.09	10	5
2" x 150 mm	60,3 x 3,6 mm	6070.150.09	10	5
2" x 200 mm	60,3 x 3,6 mm	6070.200.09	10	2
2 1/2" x 100 mm	76,1 x 3,6 mm	6070.100.10	16	4
2 1/2" x 120 mm	76,1 x 3,6 mm	6070.120.10	16	2
2 1/2" x 150 mm	76,1 x 3,6 mm	6070.150.10	10	2
3" x 120 mm	88,9 x 4,0 mm	6070.120.11	8	2
3" x 150 mm	88,9 x 4,0 mm	6070.150.11	6	2
3" x 200 mm	88,9 x 4,0 mm	6070.200.11	4	1
4" x 100 mm	114,3 x 4,5 mm	6070.100.12	4	1
4" x 120 mm	114,3 x 4,5 mm	6070.120.12	4	1

MEZIKUS, JEDNOSTRANNÝ ZÁVIT

MAT. 1.4404

Závit ISO 7/1 (R) x Délka	Vnější průměr potrubí (d) x síla stěny (t)	Číslo produktu	Kusů/karton	Kusů/balení
1/8" x 30 mm	10,2 x 2,0 mm	6072.030.01	1500	10
1/4" x 30 mm	13,5 x 2,3 mm	6072.030.02	1000	10
3/8" x 30 mm	17,2 x 2,3 mm	6072.030.03	600	10
1/2" x 35 mm	21,3 x 2,6 mm	6072.035.04	400	10
3/4" x 40 mm	26,9 x 2,6 mm	6072.040.05	200	10
1" x 40 mm	33,7 x 3,2 mm	6072.040.06	120	10
1 1/4" x 50 mm	42,4 x 3,2 mm	6072.050.07	60	5
1 1/2" x 50 mm	48,3 x 3,2 mm	6072.050.08	60	5
2" x 50 mm	60,3 x 3,6 mm	6072.050.09	36	6
2 1/2" x 60 mm	76,1 x 3,6 mm	6072.060.10	16	4
3" x 70 mm	88,9 x 4,0 mm	6072.070.11	12	4
4" x 80 mm	114,3 x 4,5 mm	6072.080.12	8	2

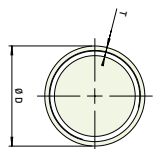
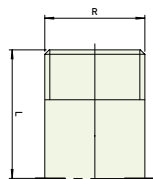
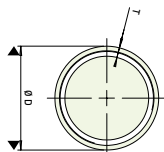
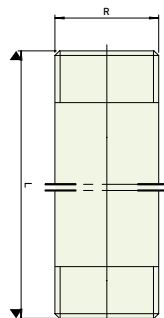

TYP 603

1/4"-2" JEDNODÍLNÝ KULOVÝ KOHOUT

- Vnitřní závit, redukovaný průtok, bezpečnostní západka - uzamčení páky
- Provedení zabraňující vystřelení hřídele při přetlakování
- Celonerezové provedení
- Stupeň maximálního tlaku: PN 63

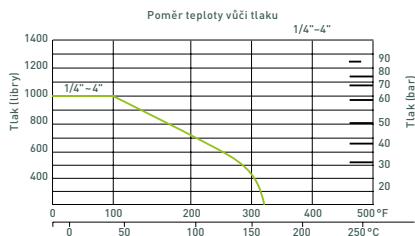

603

JEDNODÍLNÝ KULOVÝ KOHOUT, VNITŘNÍ ZÁVIT, REDUKOVANÝ PRŮTOK, BEZPEČNOSTNÍ ZÁPADKA - UZAMČENÍ PÁKY

MAT. 1.4408

Velikost	Číslo produktu	Rozměry [MM]						Váha KG
		d	L	L1	H	W	S	
1/4"	603-014	5.0	39.0	19.0	30.0	70.0	17.0	0.060
3/8"	603-038	6.8	44.0	21.0	34.0	90.0	21.0	0.100
1/2"	603-012	9.2	56.5	27.5	41.0	100.0	25.0	0.175
3/4"	603-034	12.5	59.0	29.0	44.0	100.0	32.0	0.240
1"	603-100	15.0	71.0	34.5	50.0	110.0	38.0	0.390
1 1/4"	603-114	20.0	78.0	37.0	55.0	110.0	48.0	0.610
1 1/2"	603-112	25.0	83.0	40.0	64.0	135.0	53.0	0.760
2"	603-200	32.0	100.0	49.0	70.0	145.0	65.0	1.175

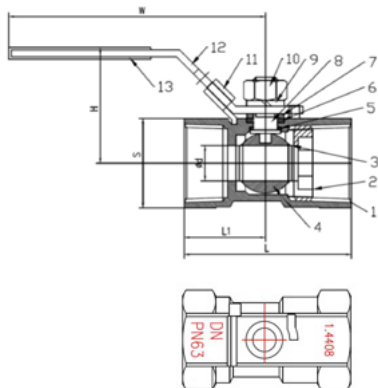

Č.	Díly	Množství	Materiál
1	Tělo	1	ASTM - A351 - CF8M
2	Vsuvka	1	ASTM - A351 - CF8M
3	Těsnění koule	2	PTFE
4	Koule	1	ASTM - A351 - CF8M
5	Podložka těsnící	1	PTFE
6	Těsnění hřídele	1	PTFE
7	Podložka	1	AISI 304
8	Hřídel	1	AISI 316
9	Podložka	1	AISI 304
10	Matice	1	AISI 304
11	Aretace páky	1	AISI 304
12	Páka	1	AISI 304
13	Potah páky	1	PLAST

TYP 604

1/4"-3" DVOUDÍLNÝ KULOVÝ KOHOUT

- Vnitřní závit, plný průtok,
- DIN 3202 M3, bezpečnostní západka - uzamčení páky
- Provedení zabraňující vystřelení hřídele při přetlakování
- Celonerezové provedení
- Stupeň maximálního tlaku: PN 63

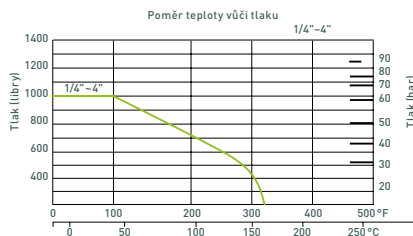

604

DVOUDÍLNÝ KULOVÝ KOHOUT, VNITŘNÍ ZÁVIT, PLNÝ PRŮTOK
DIN 3202 M3. BEZPEČNOSTNÍ ZÁPADKA - UZAMČENÍ PÁKY

Velikost	Číslo produktu	Rozměry [MM]				Váha KG
		d	L	H	W	
1/4"	604-014	11.6	55.0	51.0	95.0	0.220
3/8"	604-038	12.7	60.0	51.0	95.0	0.200
1/2"	604-012	15.0	75.0	53.0	95.0	0.300
3/4"	604-034	20.0	80.0	59.0	110.0	0.460
1"	604-100	25.0	90.0	73.0	135.0	0.720
1 1/4"	604-114	32.0	110.0	78.0	135.0	1.180
1 1/2"	604-112	38.0	120.0	91.0	147.0	1.820
2"	604-200	50.0	140.0	99.0	165.0	2.820
2 1/2"	604-212	65.0	185.0	130.0	215.0	5.580
3"	604-300	80.0	205.0	142.0	215.0	9.240

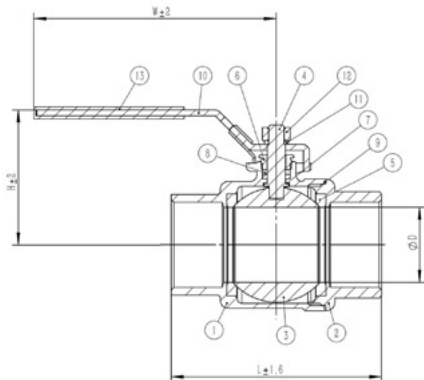

Č.	Dílý	Množství	Materiál
1	Tělo	1	ASTM-CFM8-A351
2	Vršek	1	ASTM-CFM8-A351
3	Koule	1	ASTM-CFM8-A351
4	Hřídel	1	AISI 316
5	Těsnění koule	2	PTFE
6	Podložka těsnící	1	PTFE
7	Matice	1	AISI 304
8	Těsnění hřídele	2	PTFE
9	Těsnění spojení	1	PTFE
10	Páka	1	AISI 304
11	Těsnění hřídele	1	AISI 304
12	Podložka	1	AISI 304
13	Potah páky	1	PLAST

TYP 605

1/4"-4" DVOUDÍLNÝ EKO KULOVÝ KOHOUT

- Vnitřní závit, plný průtok, bezpečnostní západka - uzamčení páky
- Provedení zabraňující vystřelení hřídele při přetlakování
- Celonerezové provedení
- Stupeň maximálního tlaku: PN 63

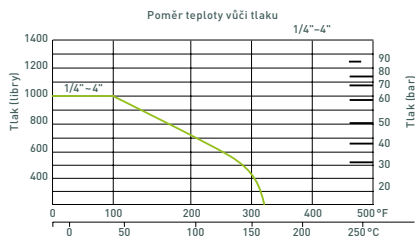

605

DVOUDÍLNÝ EKO KULOVÝ KOHOUT, VNITŘNÍ ZÁVIT, PLNÝ PRŮTOK. BEZPEČNOSTNÍ ZÁPADKA - UZAMČENÍ PÁKY

MAT. 1.4408

Velikost	Číslo produktu	Rozměry [mm]				Váha KG
		L	D	H	W	
1/4"	605-014	49.0	11.6	48.0	95.0	0.220
3/8"	605-038	49.0	12.7	48.0	95.0	0.200
1/2"	605-012	57.0	15.0	48.5	95.0	0.208
3/4"	605-034	65.0	20.0	54.5	108.0	0.319
1"	605-100	77.0	25.0	58.0	108.0	0.490
1 1/4"	605-114	90.0	32.0	70.5	130.0	0.792
1 1/2"	605-112	98.0	38.0	76.0	130.0	1.500
2"	605-200	121.0	50.0	83.5	165.0	2.057
2 1/2"	605-212	145.0	65.0	125.0	215.0	4.280
3"	605-300	166.0	80.0	136.0	215.0	6.400
4"	605-400	198.0	100.0	165.0	270.0	16.200

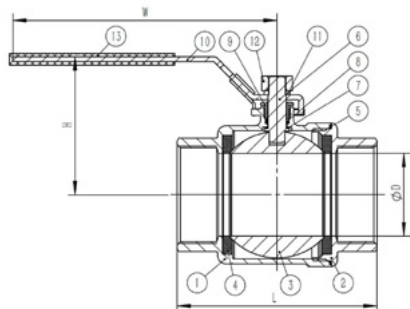

Č.	Díly	Množství	Materiál
1	Tělo	1	ASTM - A351 - CF8M
2	Vršek	1	ASTM - A351 - CF8M
3	Koule	1	ASTM - A351 - CF8M
4	Těsnění koule	2	PTFE
5	Těsnění spojení	1	PTFE
6	Hřídel	1	AISI 316
7	Podložka těsnící	1	PTFE
8	Těsnění hřídele	1	PTFE
9	Matice	1	AISI 304
10	Páka	1	AISI 304
11	Podložka	1	AISI 304
12	Matice	1	AISI 304
13	Potah páky	1	PLAST

TYP 607

1/4"-4" TROJDÍLNÝ KULOVÝ KOHOUT

- Oboustranné varné, plný průtok, bezpečnostní západka - uzamčení páky
- Provedení zabraňující vystřelení hřídele při přetlakování
- Celonerezové provedení
- Stupeň maximálního tlaku: PN 63

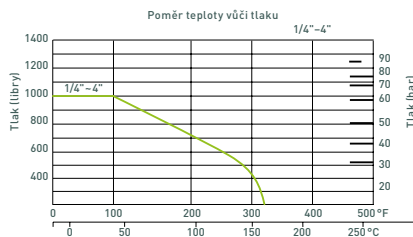

607

TROJDÍLNÝ KULOVÝ KOHOUT, OBOUSTRANNÉ VARNÉ, PLNÝ PRŮTOK, BEZPEČNOSTNÍ ZÁPADKA - UZAMČENÍ PÁKY

MAT. 1.4408

Velikost	Číslo produktu	Rozměry [mm]						Váha KG
		d	L	H	W	B	D	
ISO TOP								
1/4" [13.5]	607-014	11.6	59.0	51.0	95.0	12.0	18.0	0.320
3/8" [17.2]	607-038	12.7	59.0	51.0	95.0	14.0	18.0	0.330
DIN 3202 M3								
1/2" [21.3]	607-012	15.0	75.0	55.0	95.0	15.5	21.3	0.449
3/4" [26.9]	607-034	20.0	80.0	59.0	110.0	21.1	26.9	0.635
1" [33.7]	607-100	25.0	90.0	73.0	135.0	27.3	33.7	0.910
1 1/4" [42.4]	607-114	32.0	110.0	78.0	135.0	35.2	42.4	1.505
1 1/2" [48.3]	607-112	38.0	120.0	91.0	147.0	41.1	48.3	2.065
2" [60.3]	607-200	50.0	140.0	99.0	165.0	52.3	60.3	3.150
2 1/2" [76.1]	607-212	65.0	185.0	130.0	215.0	65.0	76.1	6.685
3" [88.9]	607-300	80.0	205.0	142.0	215.0	80.0	88.9	9.790
4" [114.3]	607-400	100.0	240.0	174.0	310.0	102.0	115.0	20.320

Položky DIN3202 M3

Č.	Díly	Množství	Materiál
1	Tělo	1	ASTM - A351 - CF8M
2	Vršek	2	ASTM - A351 - CF8M
3	Koule	1	ASTM - A351 - CF8M
4	Těsnění koule	2	PTFE
5	Hřídel	1	AISI 316
6	Podložka těsnící	1	PTFE
7	Těsnění hřídele	2	PTFE
8	Matice	1	AISI 304
9	Handle	1	AISI 304
10	Podložka	1	AISI 304
11	Matice	1	AISI 304
12	Potah páky	1	PLASTIC
13	Šroub	6	AISI 304
14	Podložka	6	AISI 304
15	Šestihranná matice	6	AISI 304

Technický výkres pro položky DIN3202 M3

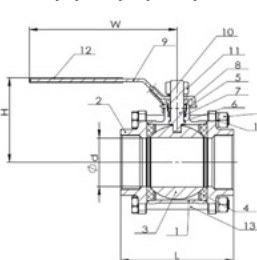

Položky ISO TOP*

Nº.	Díly	Množství	Materiál
1	Šroub	4-6	AISI 304
2	Těsnění koule	2	PTFE
3	Tělo	1	ASTM - A351 - CF8M
4	Koule	1	ASTM - A351 - CF8M
5	Těsnění spojení	2	PTFE
6	Vršek	2	ASTM - A351 - CF8M
7	Podložka	4-6	AISI 304
8	Šestihranná matice	4-6	AISI 304
9	Podložka těsnící	1	PTFE
10	Hřídel	1	AISI 316
11	Těsnění hřídele	1	PTFE
12	Matice	1	AISI 304
13	Páka	1	AISI 304
14	Podložka	1	AISI 304
15	Matice	1	AISI 304
16	Aretace páky	1	AISI 304
17	Potah páky	1	PLAST

*Technické výkresy těchto produktů si vyžádejte v naší kanceláři.

TYP 608

1/4"-4" TROJDÍLNÝ KULOVÝ KOHOUT

- Vnitřní závit, plný průtok, bezpečnostní západka - uzamčení páky
- Provedení zabraňující vystřelení hřídele při přetlakování
- Celonerezové provedení
- Stupeň maximálního tlaku: PN 63

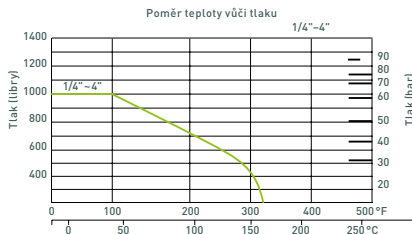

608

TROJDÍLNÝ KULOVÝ KOHOUT, VNITŘNÍ ZÁVIT, PLNÝ PRŮTOK, BEZPEČNOSTNÍ ZÁPADKA - UZAMČENÍ PÁKY

MAT. 1.4408

Velikost	Číslo produktu	Rozměry [mm]				Váha KG
		d	L	H	W	
ISO TOP						
1/4"	608-014	11.6	59.0	51.0	95.0	0.320
3/8"	608-038	12.7	59.0	51.0	95.0	0.330
DIN 3202 M3						
1/2"	608-012	15.0	75.0	55.0	95.0	0.474
3/4"	608-034	20.0	80.0	59.0	110.0	0.651
1"	608-100	25.0	90.0	73.0	135.0	0.911
1 1/4"	608-114	32.0	110.0	78.0	135.0	1.466
1 1/2"	608-112	38.0	120.0	91.0	147.0	2.073
2"	608-200	50.0	140.0	99.0	165.0	3.492
2 1/2"	608-212	65.0	185.0	130.0	215.0	6.564
3"	608-300	80.0	205.0	142.0	215.0	10.480
4"	608-400	100.0	240.0	174.0	310.0	20.470

Položky DIN3202 M3

Č.	Díly	Mno-žství	Materiál
1	Tělo	1	ASTM - A351 - CF8M
2	Vršek	2	ASTM - A351 - CF8M
3	Koule	1	ASTM - A351 - CF8M
4	Těsnění koule	2	PTFE
5	Hřídel	1	AISI 316
6	Podložka těsnící	1	PTFE
7	Těsnění hřídele	2	PTFE
8	Matice	1	AISI 304
9	Páka	1	AISI 304
10	Podložka	1	AISI 304
11	Matice	1	AISI 304
12	Potah páky	1	PLASTIC
13	Šroub	6	AISI 304
14	Podložka	6	AISI 304
15	Šestihranná matice	6	AISI 304

Technický výkres pro položky DIN3202 M3

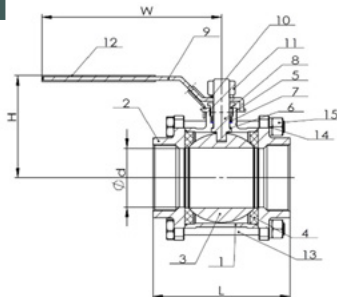

Položky ISO TOP*

Č.	Díly	Mno-žství	Materiál
1	Šroub	4-6	AISI 304
2	Těsnění koule	2	PTFE
3	Tělo	1	ASTM - A351 - CF8M
4	Koule	1	ASTM - A351 - CF8M
5	Těsnění spojení	2	PTFE
6	Vršek	2	ASTM - A351 - CF8M
7	Podložka	4-6	AISI 304
8	Šestihranná matice	4-6	AISI 304
9	Podložka těsnící	1	PTFE
10	Hřídel	1	AISI 316
11	Těsnění hřídele	1	PTFE
12	Matice	1	AISI 304
13	Páka	1	AISI 304
14	Podložka	1	AISI 304
15	Matice	1	AISI 304
16	Aretace páky	1	AISI 304
17	Potah páky	1	PLAST

*Technické výkresy těchto produktů si vyžádejte v naší kanceláři.

TYP 609

1/2"-1" NEREZOVÉ ZAHRADNÍ KULOVÉ KOHOUTY

- Jednodílný plnopřítokový kulový kohout s bezpečnostní západkou a hadicovou přípojkou
- Vnější závitové připojení DIN EN 10226-1/ISO 7/1
- Média: Studená a teplá voda
- Max. provozní tlak: PN 16



609

JEDNODÍLNÝ PLNOPRŮTOKOVÝ KULOVÝ KOHOUT S BEZPEČNOSTNÍ ZÁPADKOU A HADICOVOU PŘÍPOJKOU

Velikost		Výrobek č.	Rozměry [mm]							Váha Kg
DN			L	E	H	D	A	G	B	
15	1/2"	609-012	138	90	103	10,0	1/2"	13,0	3/4"	0.232
20	3/4"	609-034	143	90	115	12,8	3/4"	20,0	1"	0.344
25	1"	609-100	145	90	126	15,0	1"	25,4	1 1/4"	0.507

Č.	Díly	Množství	Materiál
1	Hadice	1	ASTM - A351 - CF8M
2	Matice hadice	1	ASTM - A351 - CF8M
3	Těsnění	1	NBR
4	Tělo	1	ASTM - A351 - CF8M
5	Těsnění koule	2	PTFE
6	Koule	1	AISI 316
7	Potah páky	1	Plast
8	Aretace páky	1	AISI 304
9	Matice	1	AISI 304
10	Hřídel	1	AISI 316
11	O - Kroužek	2	NBR
12	Připojovací uzávěr	1	ASTM - A351 - CF8M
13	Podložka těsnící	1	PTFE
14	Těsnění spojení	1	PTFE

